

14th WPC

French Qualification

Part III

Innovative

Solutions

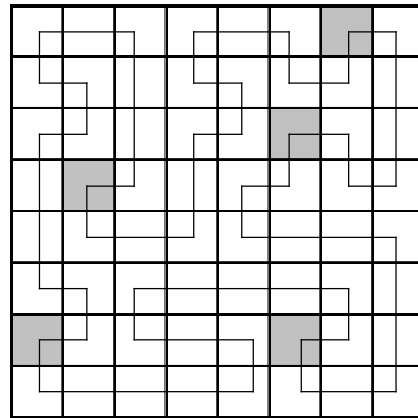
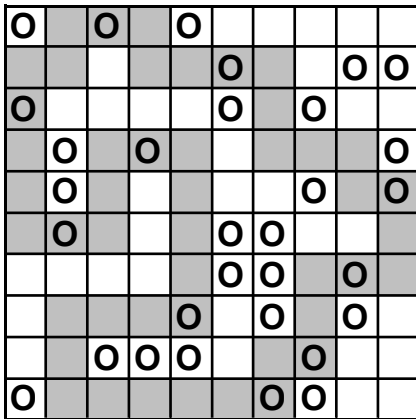

Positions not asked.

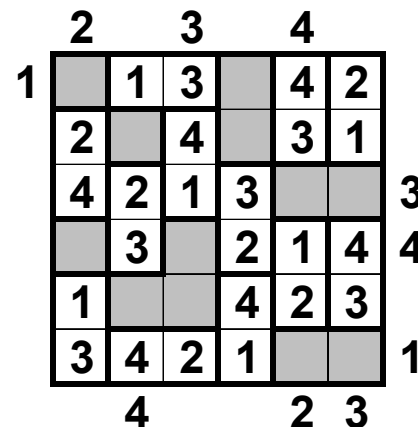
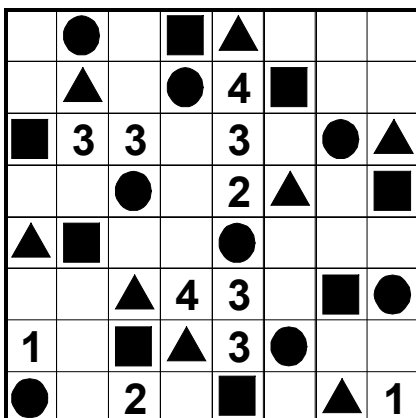
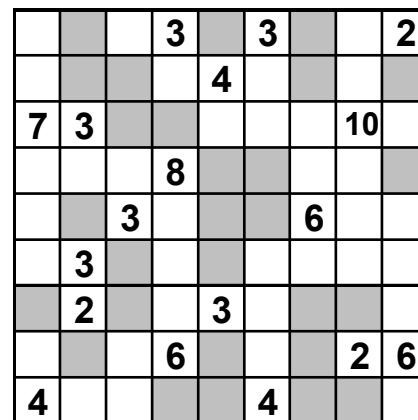
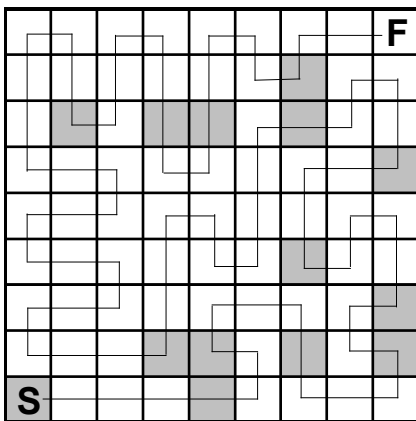

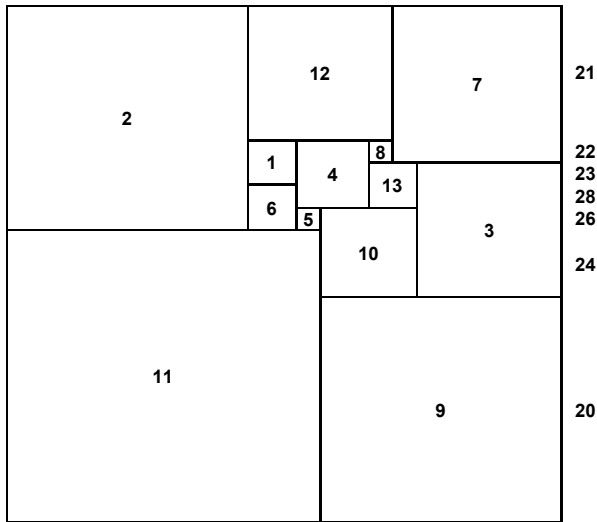
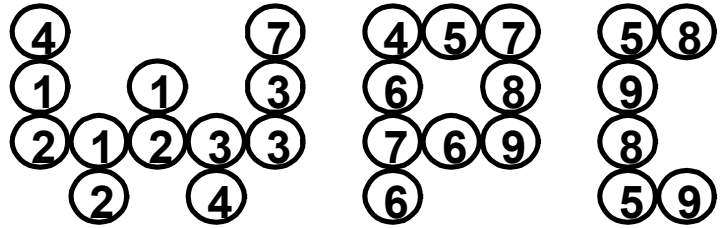
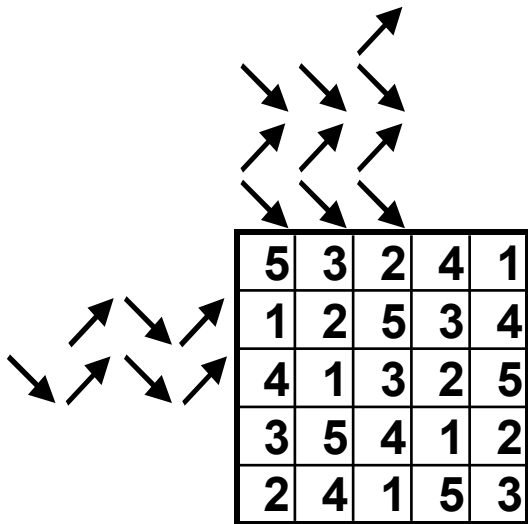

7	4	5	2	3	8	6	1
4	3	2	1	6	7	8	5
3	6	4	7	8	5	1	2
5	8	3	4	2	1	7	6
8	2	1	6	7	3	5	4
2	7	6	5	1	4	3	8
1	5	8	3	4	6	2	7
6	1	7	8	5	2	4	3

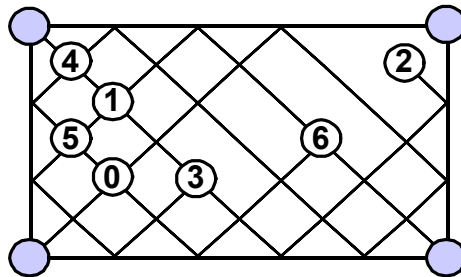
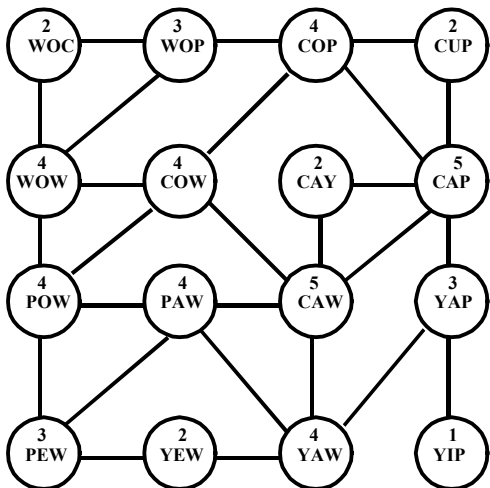

0 4 5 6 1 3 2